

### 4 PIN SOP RANDOM-PHASE TRIAC PHOTOCOUPLER ELM302X, ELM305X Series

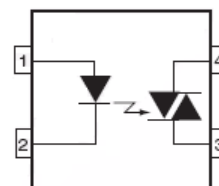

Schematic



Pin Configuration

1. Anode
2. Cathode
3. Terminal
4. Terminal

#### Features:

- Halogens free.  
(Br <900 ppm ,Cl <900 ppm , Br+Cl < 1500 ppm)
- Peak breakdown voltage
  - 400V: ELM302X
  - 600V: ELM305X
- High isolation voltage between input and output (Viso=3750 V rms )
- Compact dual-in-line package
- Compliance with EU REACH.
- Pb free and RoHS compliant.
- UL and cUL approved (No. E214129)
- VDE approved (No.132249)
- SEMKO approved
- NEMKO approved
- DEMKO approved
- FIMKO approved

#### Description

The ELM302X series and ELM305X series are optically isolated triac driver devices. These devices contain a GaAs infrared emitting diode and a light activated silicon bilateral switch, which functions like a triac.

They are designed for interfacing between electronic controls and power triacs to control resistive and inductive loads for 115 to 240 VAC operations.

#### Applications

- Solenoid/valve controls
- Lamp ballasts
- Static AC power switch
- Interfacing microprocessors to 115 to 240Vac peripherals
- Incandescent lamp dimmers
- Temperature controls
- Motor controls

**Absolute Maximum Ratings (Ta=25 °C)**

Parameter		Symbol	Rating	Unit
Input	Forward current	$I_F$	60	mA
	Reverse voltage	$V_R$	6	V
	Power Dissipation	$P_D$	100	mW
Output	Off-state Output Terminal Voltage	$V_{DRM}$	ELM302X 400	V
			ELM305X 600	
	On state RMS current	$I_{T(RMS)}$	70	mA(RMS)
	Peak Repetitive Surge Current	$I_{TSM}$	1	A
	Power dissipation	$P_C$	300	mW
Total power dissipation		$P_{TOT}$	200	mW
Isolation voltage <sup>*1</sup>		$V_{ISO}$	3750	Vrms
Operating temperature		$T_{OPR}$	-40~+110	°C
Storage temperature		$T_{STG}$	-55~+150	°C
Soldering Temperature <sup>*2</sup>		$T_{SOL}$	260	°C

Notes:

\*1 AC for 1 minute, R.H.= 40 ~ 60% R.H. In this test, pins 1, 2 are shorted together, and pins 3, 4 are shorted together.

\*2 For 10 seconds

**Electro-Optical Characteristics (Ta=25 unless specified otherwise)**

**Input**

Parameter	Symbol	Min.	Typ.*	Max.	Unit	Condition
Forward Voltage	V <sub>F</sub>	-	1.2	1.5	V	I <sub>F</sub> = 10mA
Reverse Leakage current	I <sub>R</sub>	-	-	10	μA	V <sub>R</sub> = 6V

**Output**

Parameter	Symbol	Min.	Typ.*	Max.	Unit	Condition
Peak Blocking Current	I <sub>DRM</sub>	-	-	100	nA	V <sub>DRM</sub> = Rated V <sub>DRM</sub> I <sub>F</sub> = 0mA
Peak On-state Voltage	V <sub>TM</sub>	-	-	2.5	V	I <sub>TM</sub> =100mA peak, I <sub>F</sub> =Rated I <sub>FT</sub>
Critical Rate of Rise off-state Voltage	ELM302X	-	10	-	V/μs	IF=0mA, Figure 8
	ELM305X	1000	-	-		

**Transfer Characteristics**

Parameter	Symbol	Min.	Typ.*	Max.	Unit	Condition
LED Trigger Current	3022 3052	-	-	10	mA	Main terminal Voltage=3V
	3023 3053	-	-	5		
	3024 3054	-	-	3		
Holding Current	I <sub>H</sub>	-	3	5	mA	
Turn-on time	T <sub>on</sub>	-	-	100	μS	V <sub>D</sub> =6V, R <sub>L</sub> =100ohm, I <sub>F</sub> =20mA

\* Typical values at T<sub>a</sub> = 25°C

Typical Electro-Optical Characteristics Curves

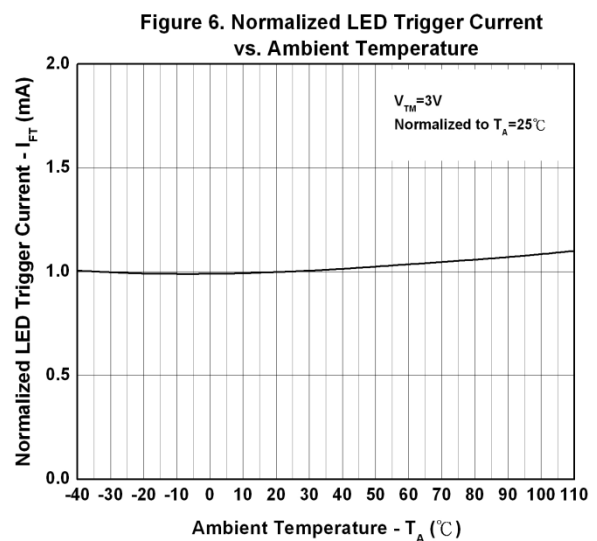
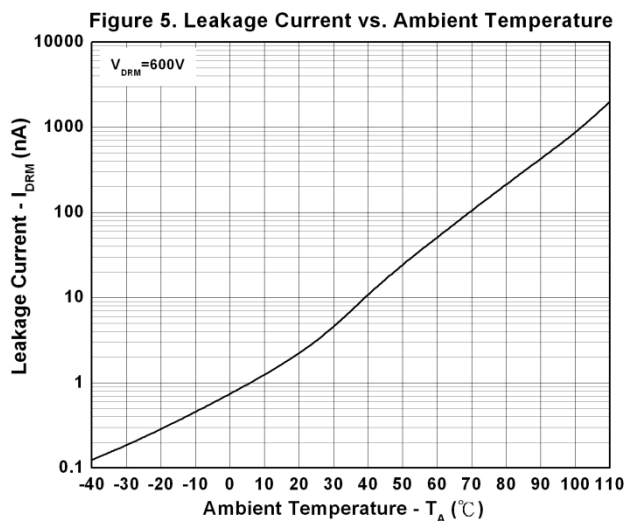
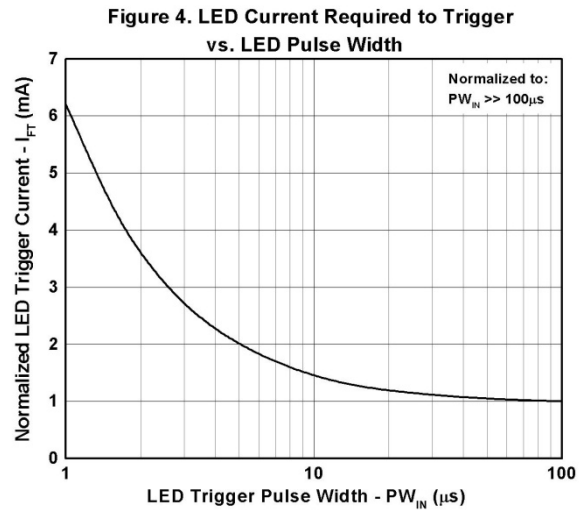
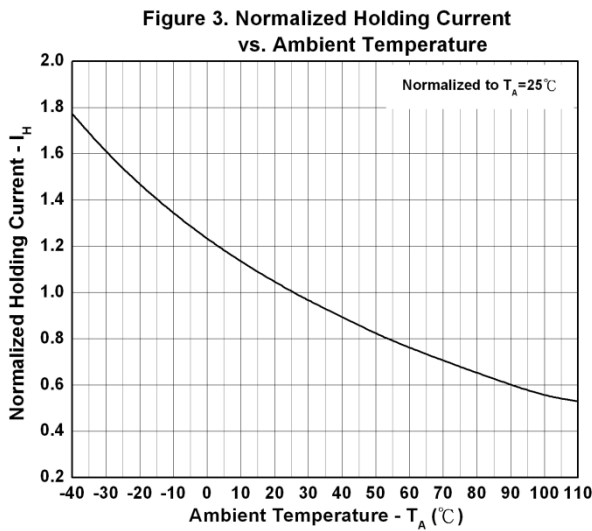
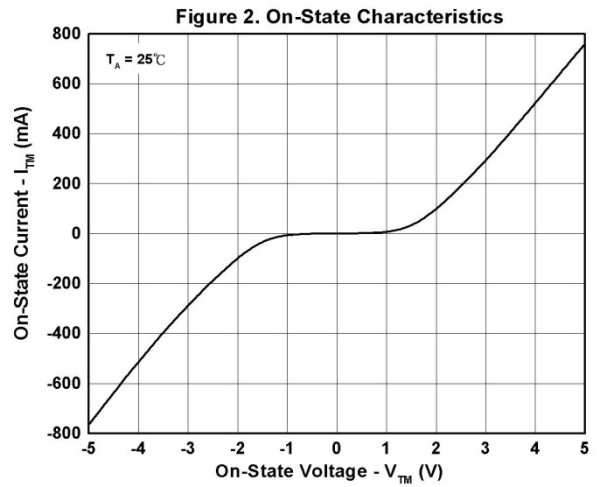
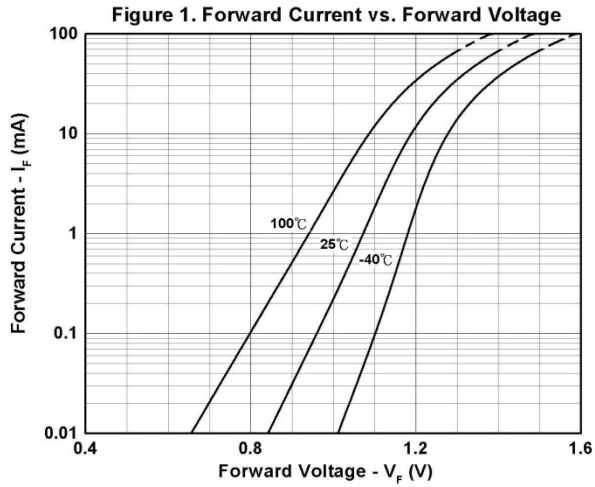

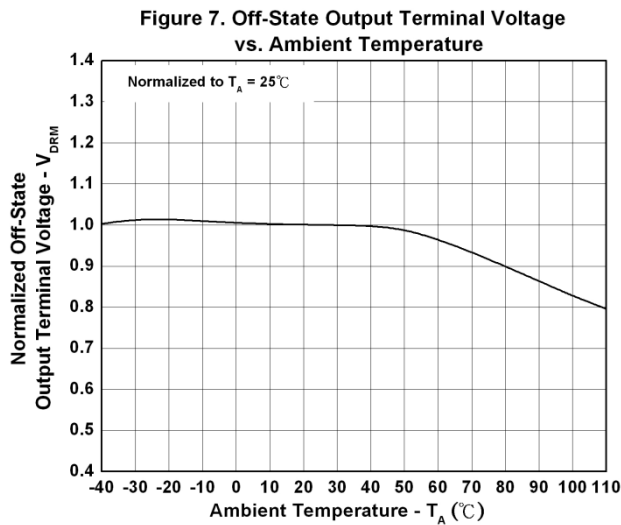

**Figure 8. Static dv/dt Test Circuit & Waveform**

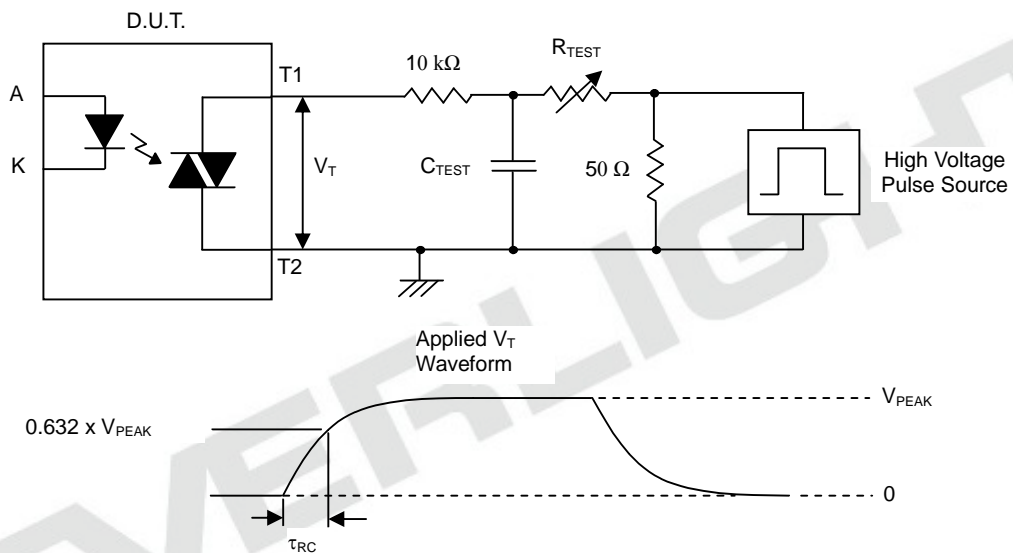

**Measurement Method**

The high voltage pulse is set to the required V<sub>PEAK</sub> value and applied to the D.U.T. output side through the RC circuit above. LED current is not applied. The waveform V<sub>T</sub> is monitored using a x100 scope probe. By varying R<sub>TEST</sub>, the dv/dt (slope) is increased, until the D.U.T. is observed to trigger (waveform collapses). The dv/dt is then decreased until the D.U.T. stops triggering. At this point, τ<sub>RC</sub> is recorded and the dv/dt calculated.

$$dv/dt = \frac{0.632 \times V_{PEAK}}{\tau_{RC}}$$

For example, V<sub>PEAK</sub> = 400V for EL302X series. The dv/dt value is calculated as follows:

$$dv/dt = \frac{0.63 \times 400}{\tau_{RC}} = \frac{252}{\tau_{RC}}$$

## Order Information

### Part Number

**ELM302X(Z)-V**  
or **ELM305X(Z)-V**

### Note

- X = Part No. (2,3 or 4 )  
Z = Tape and reel option (TA, TB or none).  
V = VDE safety approved (optional)

Option	Description	Packing quantity
None	Standard	100 units per tube
None	Standard + VDE safety optional	100 units per tube
(TA)	TA tape & reel option	3000 units per reel
(TB)	TB tape & reel option	3000 units per reel
(TA)-V	TA tape & reel option + VDE safety optional	3000 units per reel
(TB)-V	TB tape & reel option + VDE safety optional	3000 units per reel

EVERLIGHT

Package Dimension (Dimensions in mm)

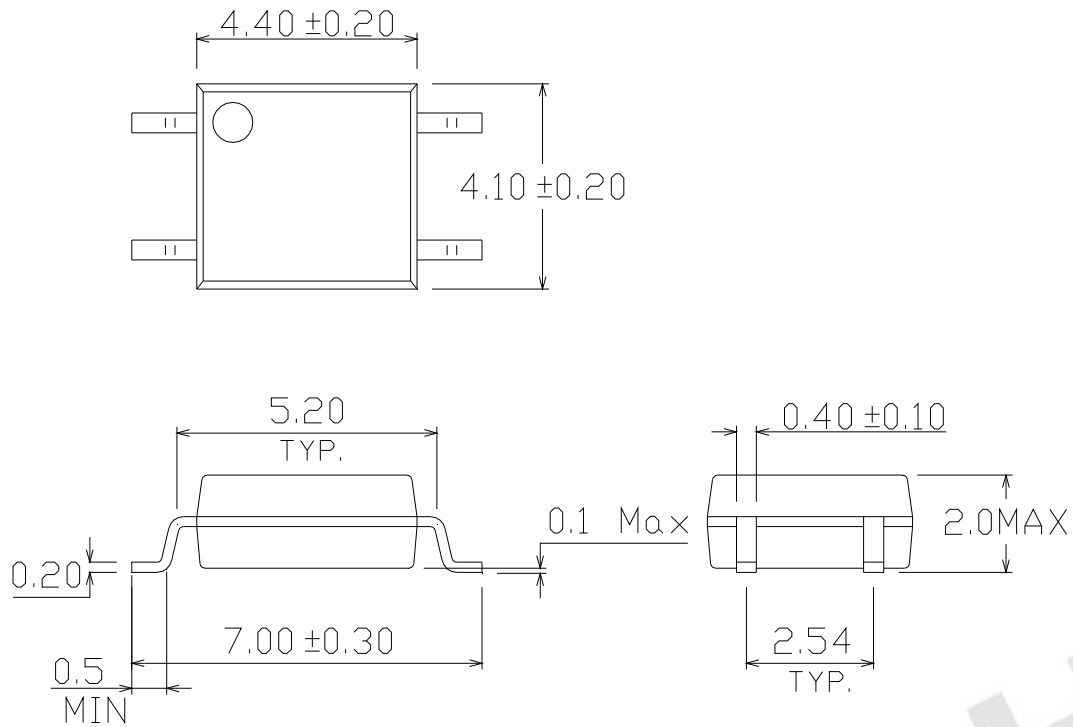

Recommended pad layout for surface mount leadform

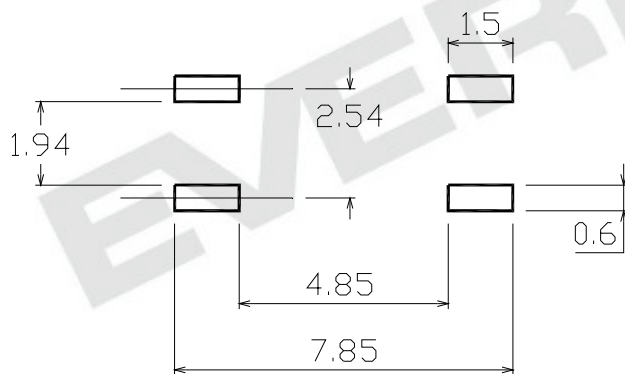

### Device Marking



### Notes

EL	denotes Everlight
M3054	denotes Device Number
Y	denotes 1 digit Year code
WW	denotes 2 digit Week code
V	denotes VDE safety option (optional)

EVERLIGHT



**Tape & Reel Packing Specifications**

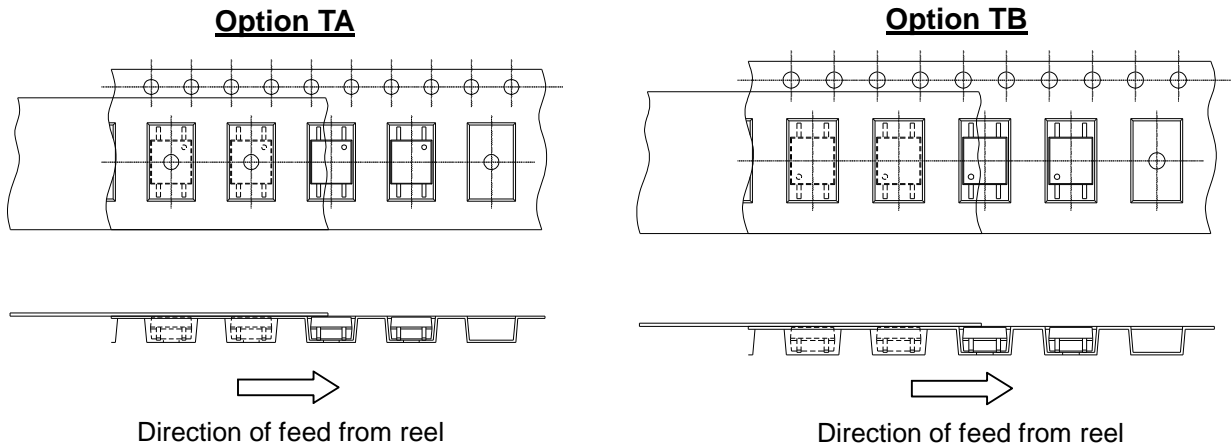

**Tape dimensions**

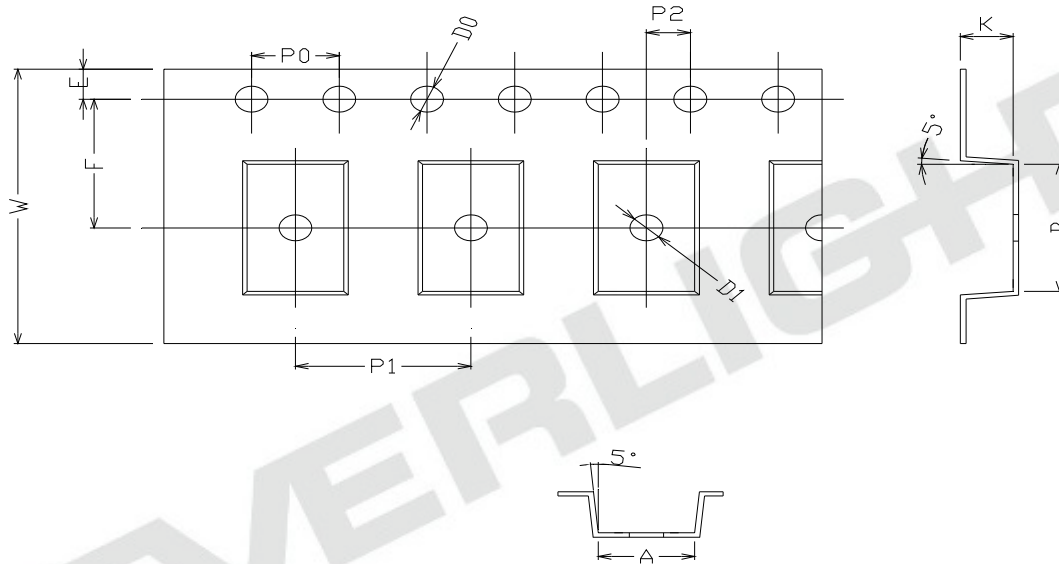

Dimension No.	A	B	Do	D1	E	F
Dimension (mm)	4.4 ± 0.1	7.4 ± 0.1	1.5 + 0.1/-0	1.5 ± 0.1	1.75 ± 0.1	7.5 ± 0.1

Dimension No.	Po	P1	P2	t	W	K
Dimension (mm)	4.0 ± 0.15	8.0 ± 0.1	2.0 ± 0.1	0.25 ± 0.03	16.0 ± 0.2	2.4 ± 0.1

**Precautions for Use**

1. Soldering Condition

1.1 (A) Maximum Body Case Temperature Profile for evaluation of Reflow Profile

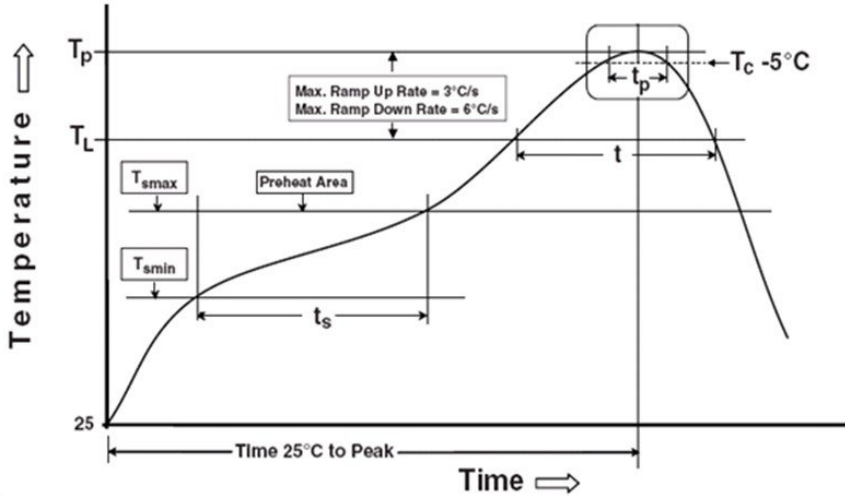

Note:

Reference: IPC/JEDEC J-STD-020D

**Preheat**

Temperature min ( $T_{smin}$ )	150 °C
Temperature max ( $T_{smax}$ )	200°C
Time ( $T_{smin}$ to $T_{smax}$ ) ( $t_s$ )	60-120 seconds
Average ramp-up rate ( $T_{smax}$ to $T_p$ )	3 °C/second max

**Other**

Liquidus Temperature ( $T_L$ )	217 °C
Time above Liquidus Temperature ( $t_L$ )	60-100 sec
Peak Temperature ( $T_P$ )	260°C
Time within 5 °C of Actual Peak Temperature: $T_P - 5^\circ\text{C}$	30 s
Ramp- Down Rate from Peak Temperature	6°C /second max.
Time 25°C to peak temperature	8 minutes max.
Reflow times	3 times

## DISCLAIMER

1. Above specification may be changed without notice. EVERLIGHT will reserve authority on material change for above specification.
2. When using this product, please observe the absolute maximum ratings and the instructions for using outlined in these specification sheets. EVERLIGHT assumes no responsibility for any damage resulting from use of the product which does not comply with the absolute maximum ratings and the instructions included in these specification sheets.
3. These specification sheets include materials protected under copyright of EVERLIGHT corporation. Please don't reproduce or cause anyone to reproduce them without EVERLIGHT's consent.

EVERLIGHT