

5 PIN LONG CREEPAGE SOP PHOTOTRANSISTOR PHOTOCOUPLER EL111X-G Series

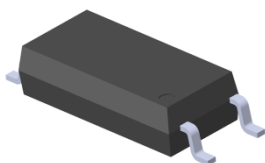

Schematic

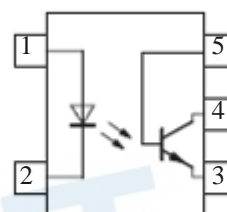

Pin Configuration

1. Anode
2. Cathode
3. Emitter
4. Collector
5. Base

Features:

- Compliance Halogen Free
(Br <900 ppm ,Cl <900 ppm , Br+Cl < 1500 ppm)
- Current transfer ratio
(CTR: 50~600% at $I_F = 5\text{mA}$, $V_{CE} = 5\text{V}$)
(CTR: 63~320% at $I_F = 10\text{mA}$, $V_{CE} = 5\text{V}$)
- High isolation voltage between input and output (Viso=5000 V rms)
- Compact 5 Pin SOP with a 2.0 mm profile
- Compliance with EU REACH
- 8mm long creepage distance
- The product itself will remain within RoHS compliant version
- UL and cUL approved(No. E214129)
- VDE approved (No. 40028391)
- SEMKO approved
- NEMKO approved
- DEMKO approved
- FIMKO approved
- CQC approved

Description

The EL111X-G series devices consist of an infrared emitting diode, optically coupled to a phototransistor detector. Compound use free halogens and Sb_2O_3 . They are packaged in a 5-pin SOP package

Applications

- Programmable controllers
- System appliances, measuring instruments
- Telecommunication equipments
- Home appliances, such as fan heaters, etc.
- Signal transmission between circuits of different potentials and impedances

Absolute Maximum Ratings (Ta=25°C)

	Parameter	Symbol	Rating	Unit
Input	Forward current	I_F	60	mA
	Peak forward current (1us, pulse)	I_{FP}	1.5	A
	Reverse voltage	V_R	6	V
	Power dissipation	P_D	100	mW
Output	Power dissipation	P_C	150	mW
	Collector current	I_C	50	mA
	Collector-Emitter voltage	V_{CEO}	80	V
	Emitter-Collector voltage	V_{ECO}	7	V
	Total Power Dissipation	P_{TOT}	250	mW
	Isolation Voltage*1	V_{ISO}	5000	V rms
	Operating Temperature	T_{OPR}	-55 to 110	°C
	Storage Temperature	T_{STG}	-55 to 125	°C
	Soldering Temperature*2	T_{SOL}	260	°C

Notes:

*1 AC for 1 minute, R.H.= 40 ~ 60% R.H. In this test, pins 1, 2 are shorted together, and pins 3, 4 & 5 are shorted together.

*2 For 10 seconds

Electro-Optical Characteristics (Ta=25°C unless specified otherwise)

Input

Parameter	Symbol	Min.	Typ.	Max.	Unit	Condition
Forward Voltage	V_F	-	-	1.5	V	$I_F = 50\text{mA}$
Reverse current	I_R	-	-	10	μA	$V_R = 6\text{V}$
Input capacitance	C_{in}	-	50	-	pF	$V = 0, f = 1\text{kHz}$

Output

Parameter	Symbol	Min	Typ.	Max.	Unit	Condition
Collector-Emitter dark current	I_{CEO}	-	-	100	nA	$V_{CE} = 20\text{V}, I_F = 0\text{mA}$
Collector-Emitter breakdown voltage	BV_{CEO}	80	-	-	V	$I_C = 0.1\text{mA}$
Emitter-Collector breakdown voltage	BV_{ECO}	7	-	-	V	$I_E = 0.1\text{mA}$

Transfer Characteristics

Parameter	Symbol	Min	Typ.	Max.	Unit	Condition	
Current Transfer ratio	EL1110	50	-	600	%	$I_F = 5\text{mA}, V_{CE} = 5\text{V}$	
	EL1116	100	-	300			
	EL1117	80	-	160			
	EL1118	130	-	260			
	EL1119	200	-	400			
	EL1112	63	-	125			
	EL1113	100	-	200	%	$I_F = 10\text{mA}, V_{CE} = 5\text{V}$	
	EL1114	160	-	320			
	EL1112	22	-	-			
	EL1113	34	-	-			
	EL1114	56	-	-		$I_F = 1\text{mA}, V_{CE} = 5\text{V}$	
	Collector-Emitter saturation voltage	$V_{CE(sat)}$	-	-	0.4	V	$I_F = 10\text{mA}, I_C = 1\text{mA}$
	Isolation resistance	R_{IO}	5×10^{10}	-	-	Ω	$V_{IO} = 500\text{Vdc}, 40\sim 60\% \text{ R.H.}$
	Floating capacitance	C_{IO}	-	-	1.0	pF	$V_{IO} = 0, f = 1\text{MHz}$

Transfer Characteristics

Parameter	Symbol	Min	Typ.	Max.	Unit	Condition
Turn on time	Ton	-	4	-	μs	V _{CE} = 5V, I _C = 5mA, R _L = 100Ω
Turn off time	Toff	-	3	-		
Rise time	t _r	-	2	18	μs	V _{CE} = 5V, I _C = 5mA, R _L = 100Ω
Fall time	t _f	-	3	18		

* Typical values at T_a = 25°C

EVERLIGHT

Typical Electro-Optical Characteristics Curves

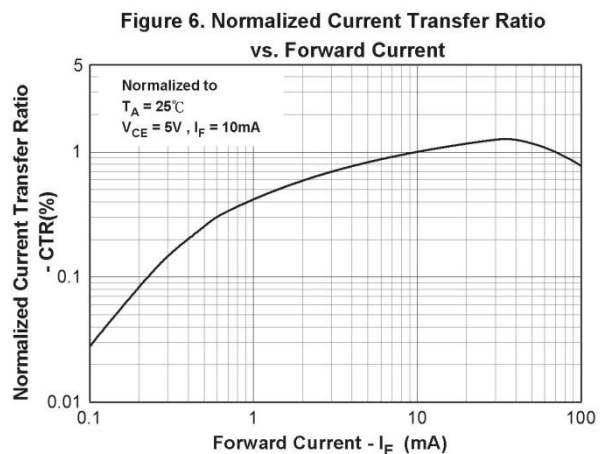
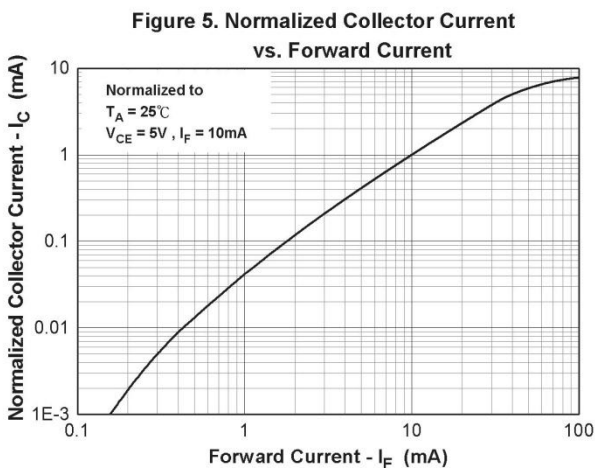
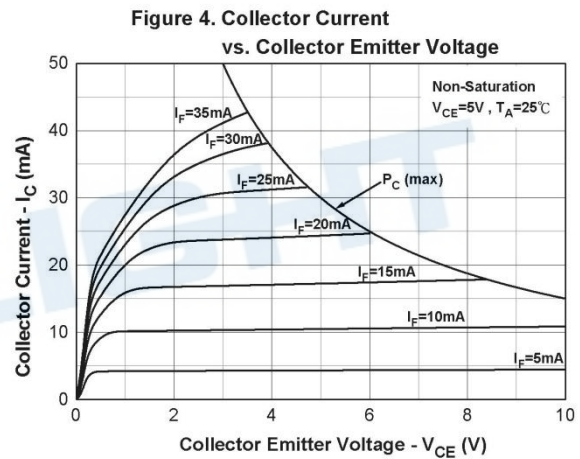
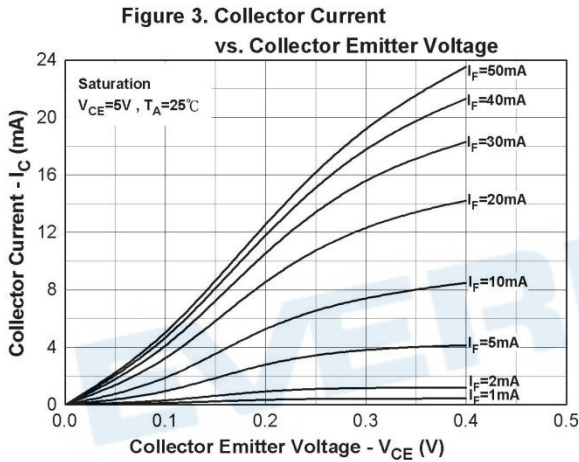
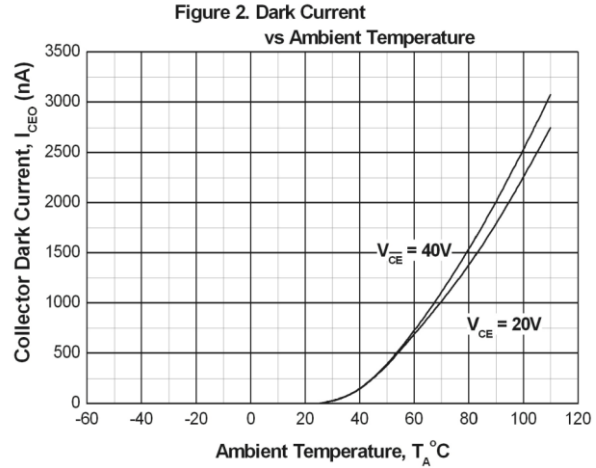
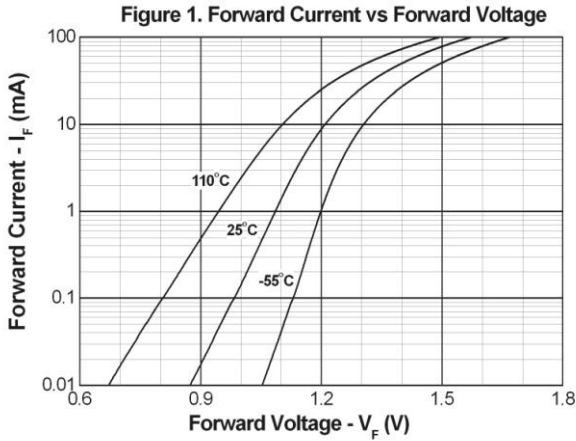

Figure 7. Normalized Current Transfer Ratio vs. Ambient Temperature

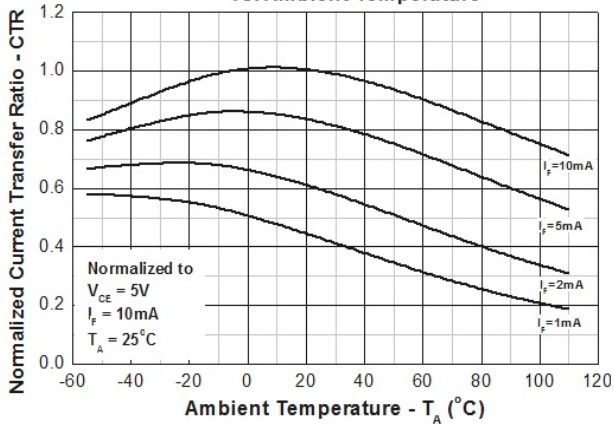

Figure 8. Normalized Current Transfer Ratio vs. Ambient Temperature

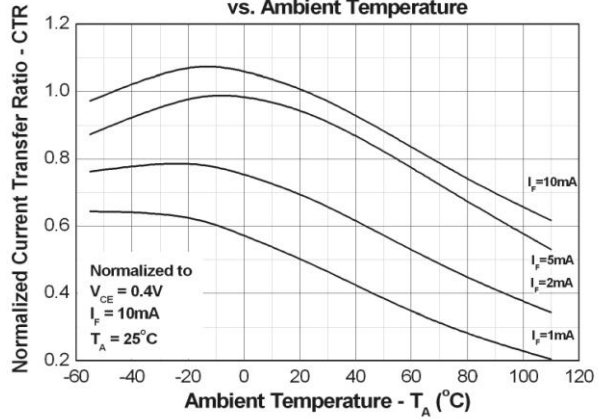

Figure 9. Turn on/off Time vs. Collector Current

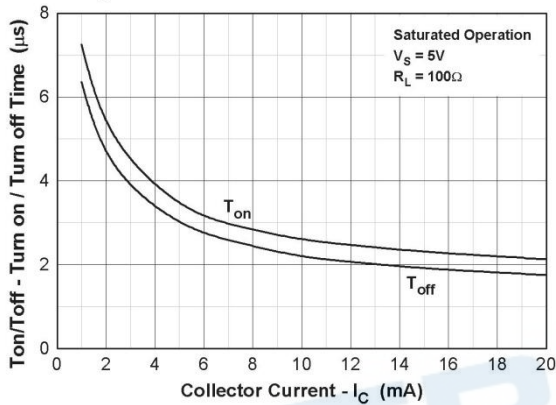

Figure 10. Turn on/off Time vs. Forward Current

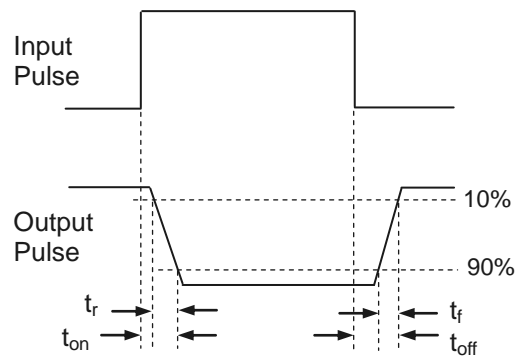
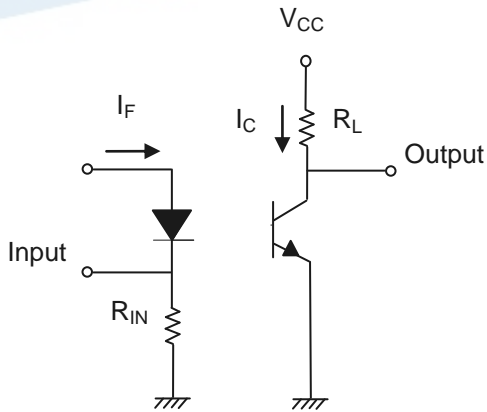
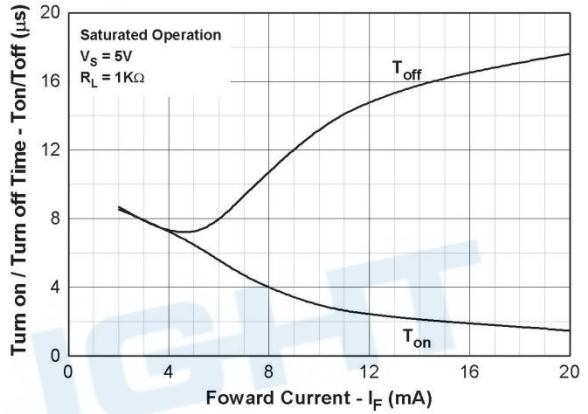

Figure 11. Switching Time Test Circuit & Waveforms

Order Information

Part Number

EL111X(Y)-VG

Note

EL111 = Part No.
X = CTR Rank (0, 2, 3, 4, 6, 7, 8 or 9)
Y = Tape and reel option (TA, TB or none).
V = VDE safety (optional)
G = Halogens free

Option	Description	Packing quantity
None	Standard SMD option	100 units per tube
-V	Standard SMD option + VDE	100 units per tube
(TA)	TA Tape & reel option	3000 units per reel
(TB)	TB Tape & reel option	3000 units per reel
(TA)-V	TA Tape & reel option + VDE	3000 units per reel
(TB)-V	TB Tape & reel option + VDE	3000 units per reel

Package Dimension (Dimensions in mm)

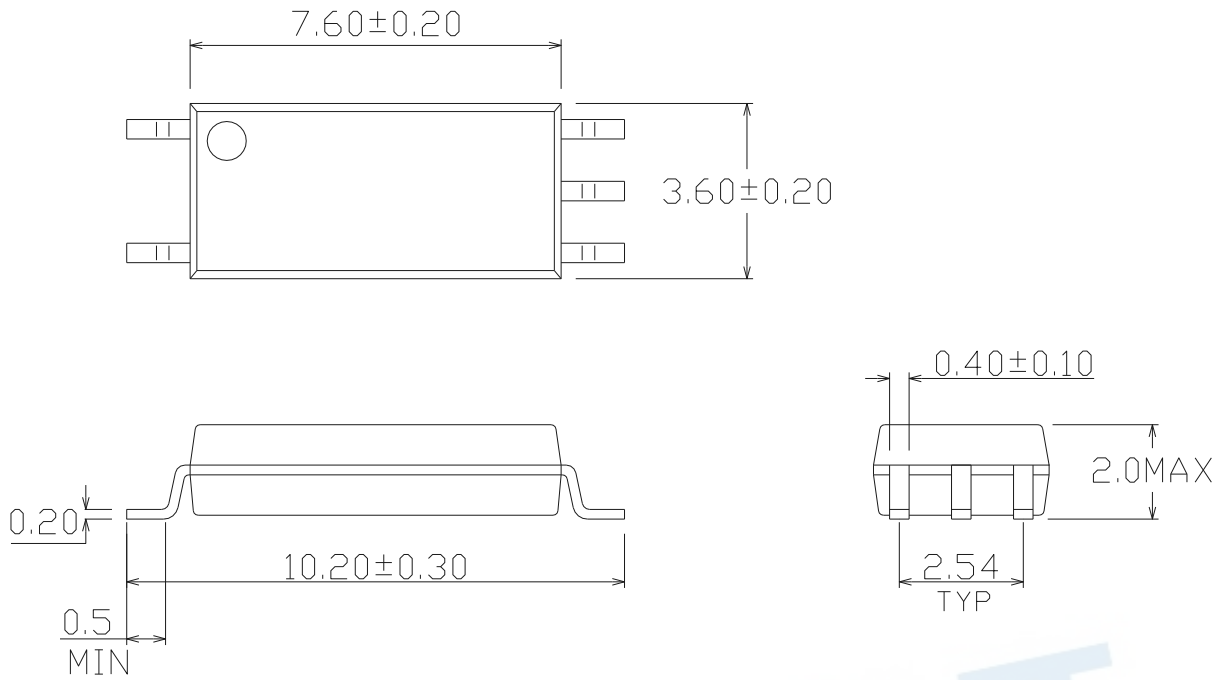

Recommended pad layout for surface mount leadform

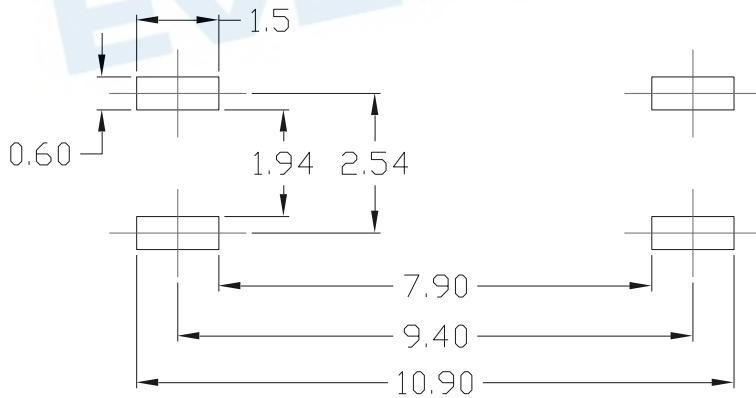

Device Marking

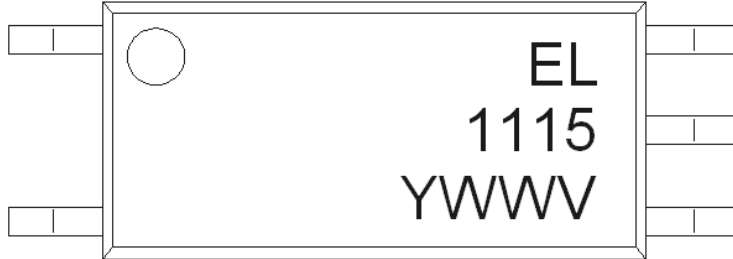

Notes

EL	denotes Everlight
1115	denotes Device Number
Y	denotes 1 digit Year code
WW	denotes 2 digit Week code
V	denotes VDE (optional)

EVERLIGHT

Tape & Reel Packing Specifications

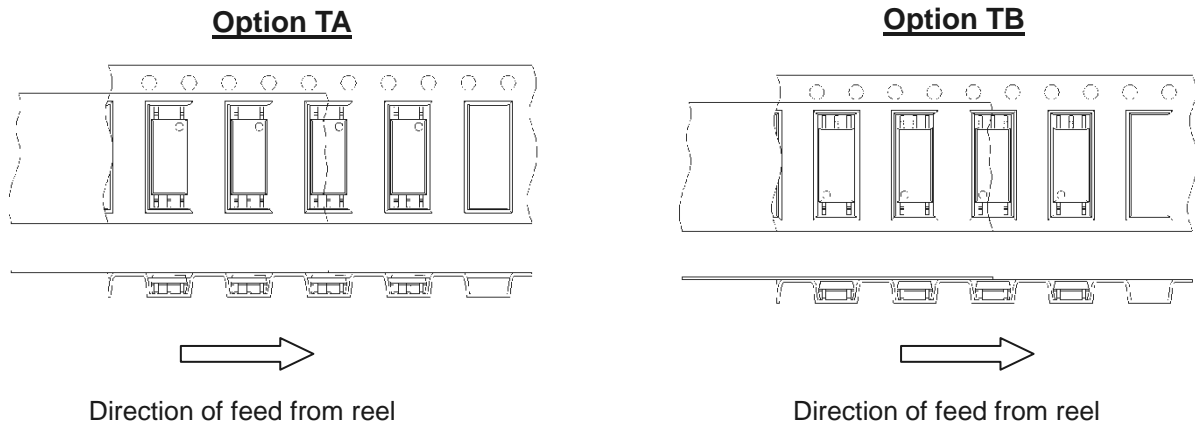

Tape dimensions

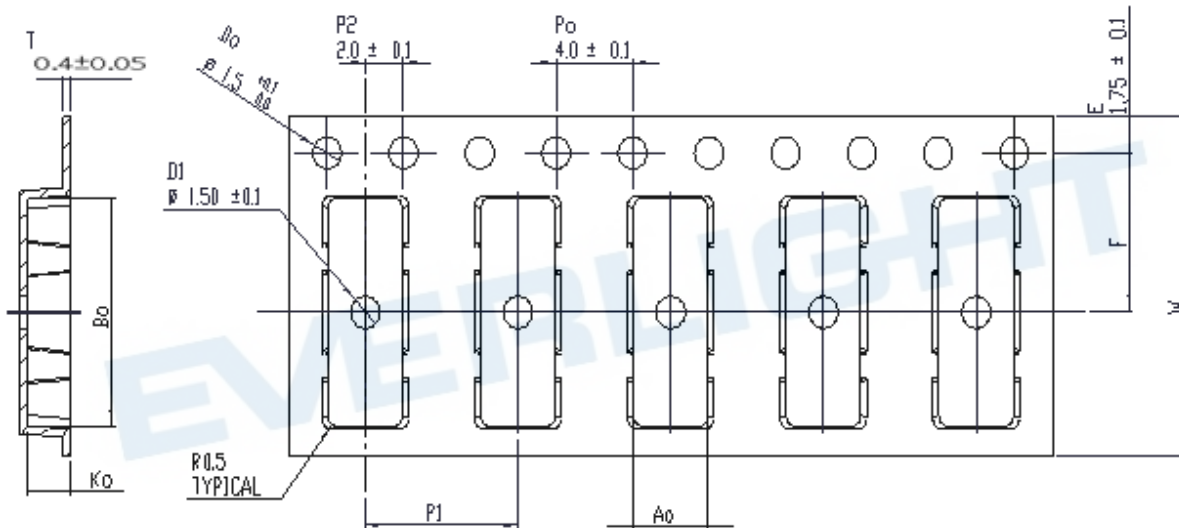

Dimension No.	Ao	Bo	Do	D1	E	F
Dimension (mm)	3.9 ± 0.10	10.75 ± 0.10	1.5 + 0.1/-0	1.5 ± 0.10	1.75 ± 0.10	7.5 ± 0.10
Dimension No.	Po	P1	P2	T	W	Ko
Dimension (mm)	4.0 ± 0.10	8.0 ± 0.10	2.0 ± 0.10	0.4 ± 0.05	16.0 ± 0.30	2.25 ± 0.10

Precautions for Use

1. Soldering Condition

1.1 (A) Maximum Body Case Temperature Profile for evaluation of Reflow Profile

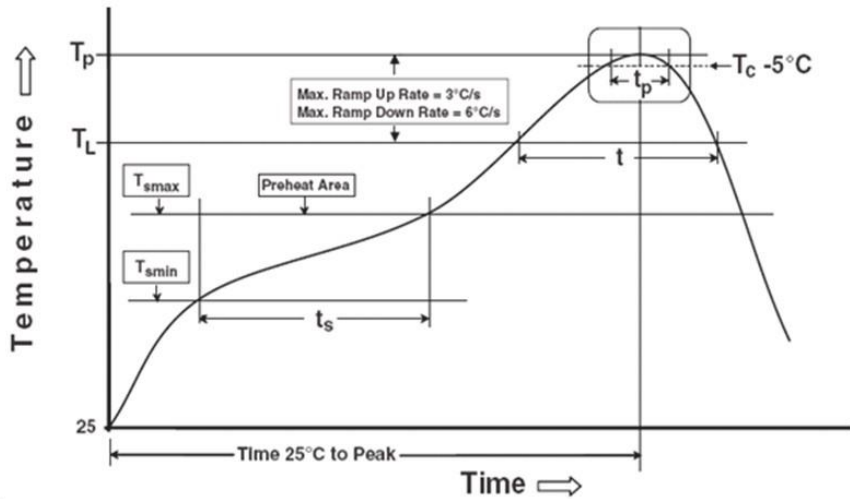

Note:

Reference: IPC/JEDEC J-STD-020D

Preheat

Temperature min (T_{smin})	150 °C
Temperature max (T_{smax})	200°C
Time (T_{smin} to T_{smax}) (t_s)	60-120 seconds
Average ramp-up rate (T_{smax} to T_p)	3 °C/second max

Other

Liquidus Temperature (T_L)	217 °C
Time above Liquidus Temperature (t_L)	60-100 sec
Peak Temperature (T_p)	260°C
Time within 5 °C of Actual Peak Temperature: $T_p - 5^\circ\text{C}$	30 s
Ramp- Down Rate from Peak Temperature	6°C /second max.
Time 25°C to peak temperature	8 minutes max.
Reflow times	3 times

DISCLAIMER

1. Above specification may be changed without notice. EVERLIGHT will reserve authority on material change for above specification.
2. The graphs shown in this datasheet are representing typical data only and do not show guaranteed values.
3. When using this product, please observe the absolute maximum ratings and the instructions for use outlined in these specification sheets. EVERLIGHT assumes no responsibility for any damage resulting from use of the product which does not comply with the absolute maximum ratings and the instructions included in these specification sheets.
4. These specification sheets include materials protected under copyright of EVERLIGHT. Reproduction in any form is prohibited without the specific consent of EVERLIGHT.
5. This product is not intended to be used for military, aircraft, automotive, medical, life sustaining or life saving applications or any other application which can result in human injury or death. Please contact authorized Everlight sales agent for special application request.
6. Statements regarding the suitability of products for certain types of applications are based on Everlight's knowledge of typical requirements that are often placed on Everlight products in generic applications. Such statements are not binding statements about the suitability of products for a particular application. It is the customer's responsibility to validate that a particular product with the properties described in the product specification is suitable for use in a particular application. Parameters provided in datasheets and/or specifications may vary in different applications and performance may vary over time. All operating parameters, including typical parameters, must be validated for each customer application by the customer's technical experts. Product specifications do not expand or otherwise modify Everlight's terms and conditions of purchase, including but not limited to the warranty expressed therein..