

HNB2727W-OS05

Hong Series

**Features**

- Unique packaging technology provides better moisture resistance for outdoor use.
- Various options for color mixture including white.
- Good color fidelity and brightness uniformity across the viewing angle
- Black body provides better contrast for the display.
- The product itself will remain within RoHS compliant version.
- Compliance with EU REACH.
- Compliance Halogen Free .(Br <900 ppm ,Cl <900 ppm , Br+Cl < 1500 ppm)

Description

- The HNB2727W-OS05 SMD LED package provides a perfect solution when users need a clear view of signage Display with any size board with 3 in 1 full color SMD LEDs which offer smaller pixel pitch between two LEDs to create a high resolution and better contrast with its black body design.

Applications

- Outdoor signage display
- Outdoor decorating and entertainment design
- Gaming equipment.
- Indicator and backlighting for all consumer electronics.

Device Selection Guide

Part No.	Chip Materials	Emitted Color
R	AlGaInP	Brilliant Red
G	InGaN	Brilliant Green
B	InGaN	Brilliant Blue

Absolute Maximum Ratings (Ta=25°C)

Parameter	Symbol	Rating	Unit
Reverse Voltage	V_R	5	V
Forward Current	I_F	R	20
		G	20
		B	20
Peak Forward Current (Duty 1/10 @1KHz)	I_{FP}	40	mA
Power Dissipation	P_d	R	50
		G	70
		B	70
Operating Temperature	T_{opr}	-40 ~ +85	°C
Storage Temperature	T_{stg}	-40 ~ +90	°C
Soldering Temperature	T_{sol}	Reflow Soldering : 260 °C for 10 sec.	

Electro-Optical Characteristics (Ta=25°C)

Parameter	Symbol	Min.	Typ.	Max.	Unit	Condition	
Luminous Intensity	Iv	R	578	-----	1269	mcd	IF=20mA
		G	1004	-----	2206		IF=15mA
		B	170	-----	485		IF=10mA
Viewing Angle	2θ _{1/2}	-----	110	-----	deg	IF=20mA	
Dominant Wavelength	λd	R	615	-----	630	nm	IF=20mA
		G	517		535		IF=15mA
		B	465		480		IF=10mA
Spectrum Radiation Bandwidth	Δλ	R	-----	20	-----	nm	IF=20mA
		G		35			IF=15mA
		B		25			IF=10mA
Forward Voltage	VF	R	1.8	-----	2.6	V	IF=20mA
		G	2.5		3.5		IF=15mA
		B	2.5		3.5		IF=10mA
Reverse Current	IR	-----	-----	10	μA	VR=5V	

Note:

1. Tolerance of Luminous Intensity: ±10%
2. Tolerance of Dominant Wavelength: ±1nm
3. Tolerance of Forward Voltage: ±0.1V

Bin Range of Luminous Intensity

Color	Bin Code	Min.	Max.	Unit	Condition
Red	RA	578	751	mcd	$I_F = 20\text{mA}$
	RB	751	976		
	RC	976	1269		
Green	G0	1004	1305	mcd	$I_F = 15\text{mA}$
	GA	1305	1697		
	GB	1697	2206		
Blue	B0	170	221	mcd	$I_F = 10\text{mA}$
	BA	221	287		
	BB	287	373		
	BC	373	485		

Bin Range of Dominant Wavelength

Color	Bin Code	Min.	Max.	Unit	Condition
Red	R1	615	620	nm	$I_F = 20\text{mA}$
	R2	620	625		
	R3	625	630		
Green	G1	517	520	nm	$I_F = 15\text{mA}$
	G2	520	523		
	G3	523	526		
	G4	526	529		
	G5	529	532		
	G6	532	535		
Blue	B1	465	468	nm	$I_F = 10\text{mA}$
	B2	468	471		
	B3	471	474		
	B4	474	477		
	B5	477	480		

Note:

1. Tolerance of Luminous Intensity: $\pm 10\%$
2. Tolerance of Dominant Wavelength: $\pm 1\text{nm}$

Package Dimension

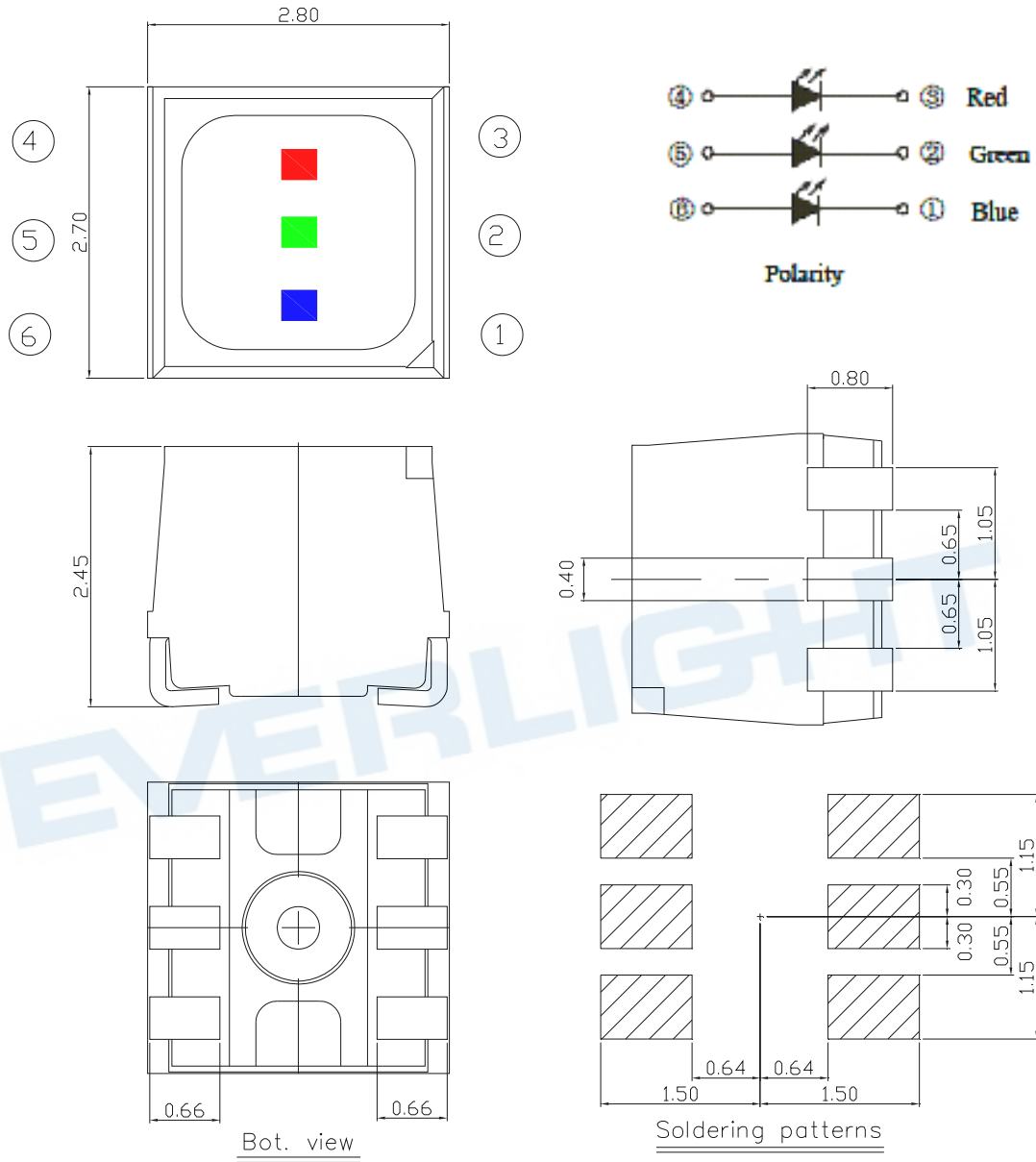

Notes:

1. Dimensions are in millimeters.
2. Tolerances for fixed dimensions are ± 0.1 mm.

Typical Electro-Optical Characteristics Curves

Relative Intensity vs. Wavelength (Ta=25°C)

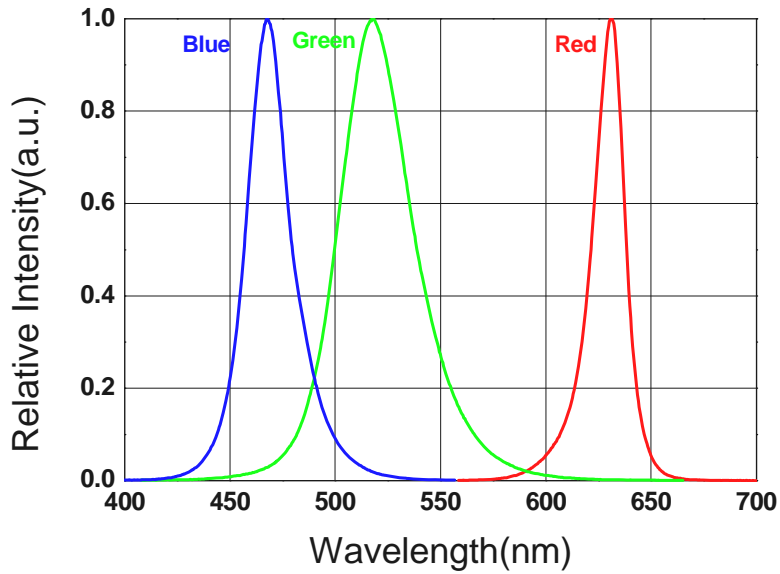

Directivity (Ta=25°C)

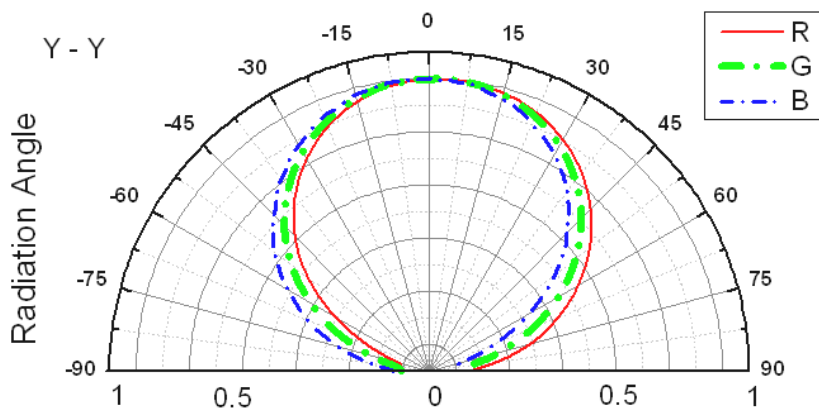
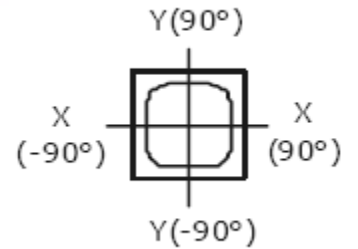
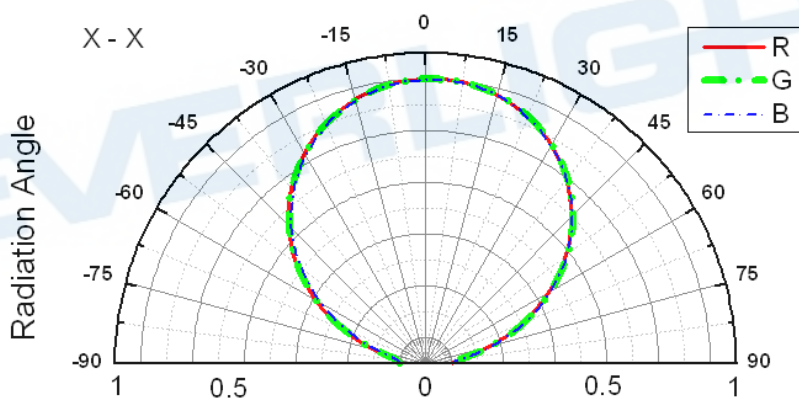

Forward Current vs. Forward Voltage (Ta=25°C)

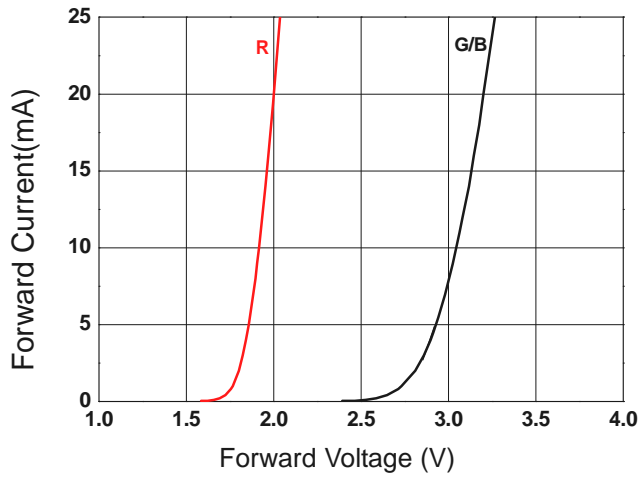

Relative Intensity vs. Forward Current (Ta=25°C)

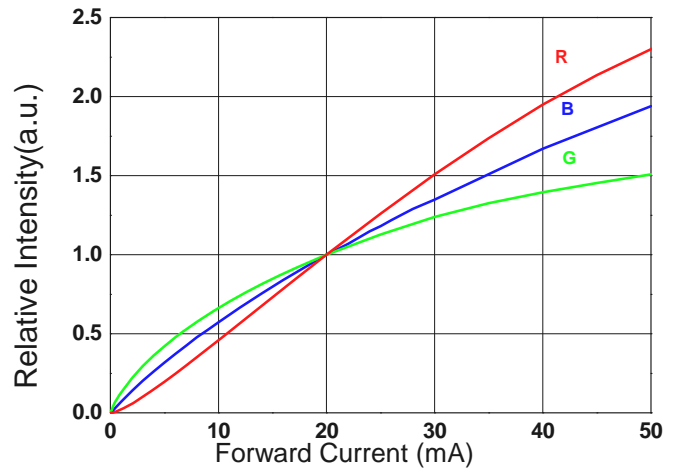

Relative Intensity vs. Ambient Temp.

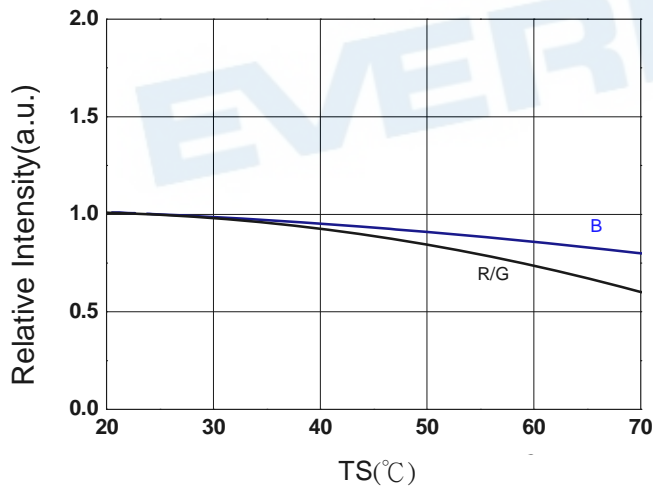

Forward Current vs. Ambient Temp.

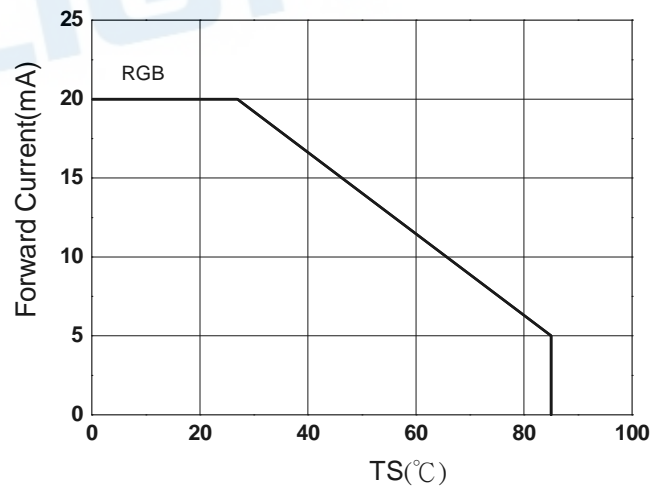

Moisture Resistant Packing Materials

Label Explanation



- CPN: Customer's Product Number
- P/N: Product Number
- QTY: Packing Quantity
- CAT: Luminous Intensity Rank
- HUE: Dom. Wavelength Rank
- REF: Forward Voltage Rank
- LOT No: Lot Number
- 1111: The date of Lot(MMDD)
- 112ABA: The second value of CAT and HUE

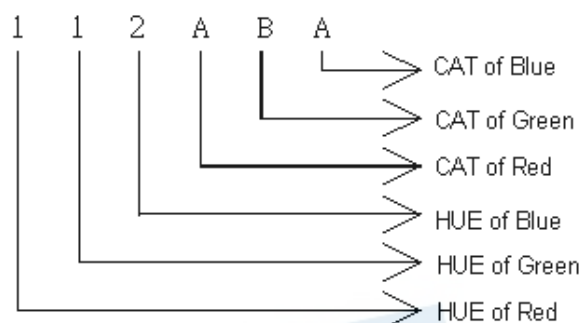

Reel Dimensions

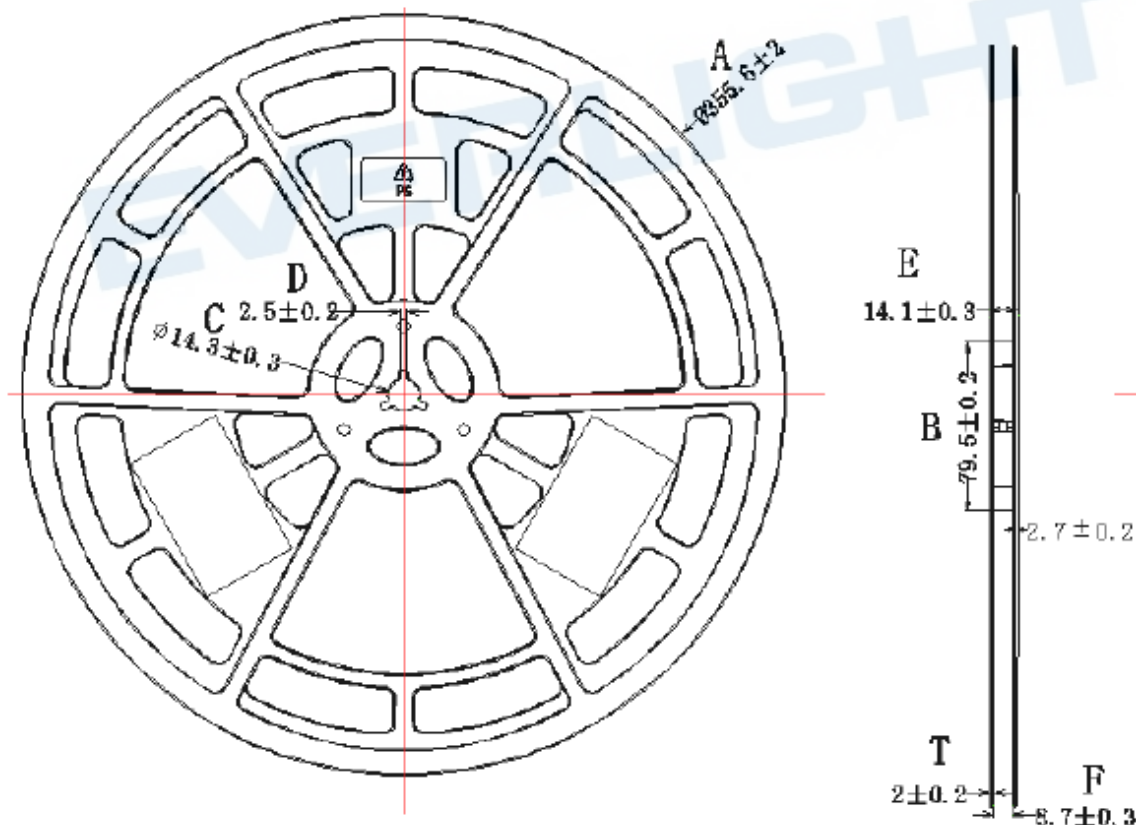

Notes:

1. Dimensions are in millimeters.
2. Tolerances for fixed dimensions are ± 0.1 mm.

Carrier Tape Dimensions:

The minimum quantity of packing is 8000 pcs per reel. The rest quantity which could not reach 8000 pcs per reel will go to 500 pcs per reel.

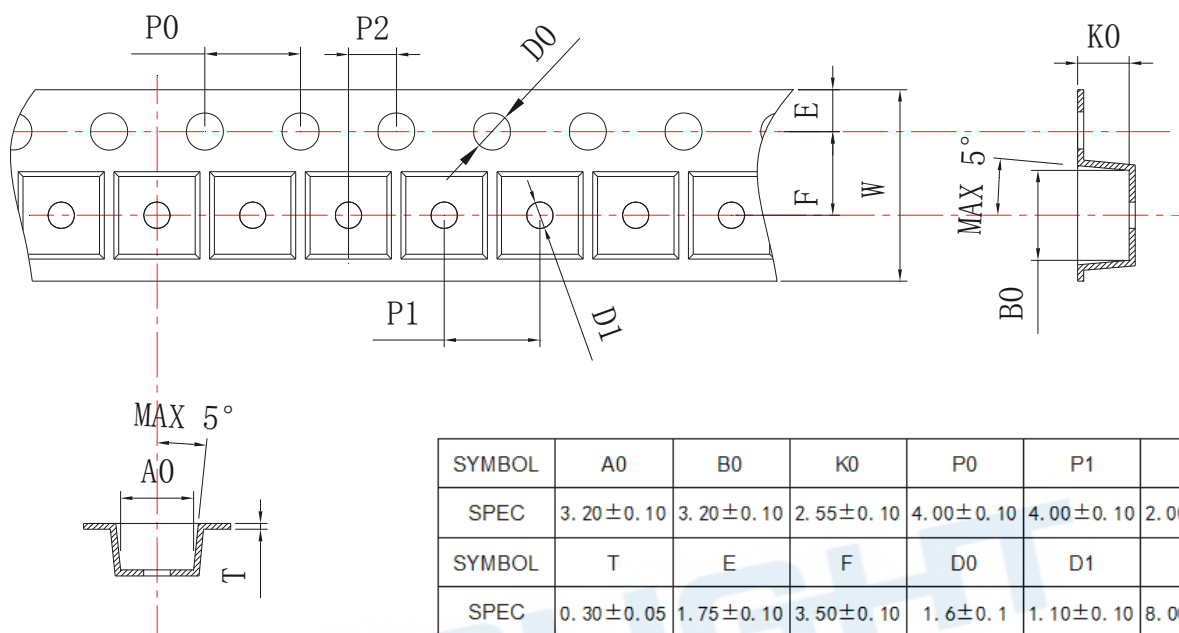

Notes:

1. Dimensions are in millimeters.
2. Tolerances for fixed dimensions are ± 0.1 mm.

Moisture Resistant Packing Process

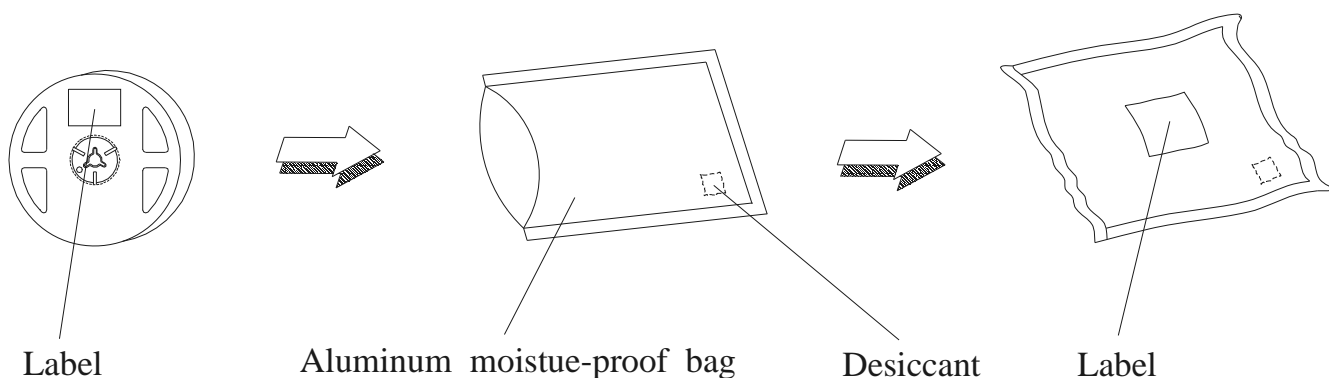

Notes:

1. Dimensions are in millimeters.
2. Tolerances for fixed dimensions are ± 0.1 mm.

Precautions for Use

1. Over-current-proof

- Customer must apply resistors for protection, otherwise slight voltage shift will cause big current change (Burn out will happen).

2. Storage

- Moisture proof and anti-electrostatic package with moisture absorbent material is used, to keep moisture to a minimum.
- Before opening the package, the product should be kept at 30°C or less and humidity less than 60%RH, and be used within 2 months.
- Before opening the sealed bag, please check whether or not the bag leaked air.
- If the bag has leaked air, baking is required, baking condition:(80±5)°C for 12 hours.
- Before soldering the product must be stored under the condition <30°C and <60%RH. Under these conditions the SMD LEDs must be used (subject to reflow) in 12 hours. If the product is under the condition <30°C and <10%RH, the storage time can be extended to 48hours
- Re-baking is required when exceeding the specified time. Baking condition is as above.

3. Soldering Condition

- Pb -free solder temperature profile

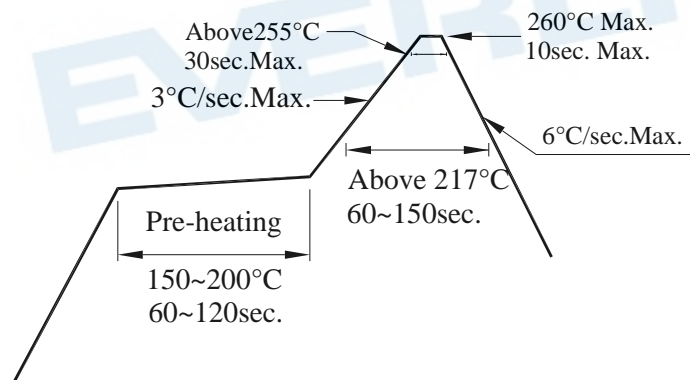

- Reflow soldering should not be done more than two times.
- When soldering, do not put stress on the LEDs during heating.
- After soldering, do not warp the circuit board.

4. ESD (Electrostatic Discharge)

- The products are sensitive to static electricity or surge voltage. ESD can damage a die and its reliability. When handling the products, the following measures against electrostatic discharge are strongly recommended:

Eliminating the charge

Grounded wrist strap, ESD footwear, clothes, and floors

Grounded workstation equipment and tools

ESD table/shelf mat made of conductive materials

- Proper grounding is required for all devices, equipment, and machinery used in product assembly. Surge protection should be considered when designing of commercial products.
- If tools or equipment contain insulating materials such as glass or plastic, the following measures against electrostatic discharge are strongly recommended:
 - Dissipating static charge with conductive materials
 - Preventing charge generation with moisture
 - Neutralizing the charge with ionizers.

5. Directions for use

- The LEDs should be operated with forward bias. The driving circuit must be designed so that the LEDs are not subjected to forward or reverse voltage while it is off. If reverse voltage is continuously applied to the LEDs, it may cause migration resulting in LED damage.

DISCLAIMER

1. EVERLIGHT reserves the right(s) on the adjustment of product material mix for the specification.
2. The product meets EVERLIGHT published specification for a period of twelve (12) months from date of shipment.
3. The graphs shown in this datasheet are representing typical data only and do not show guaranteed values.
4. When using this product, please observe the absolute maximum ratings and the instructions for using outlined in these specification sheets. EVERLIGHT assumes no responsibility for any damage resulting from the use of the product which does not comply with the absolute maximum ratings and the instructions included in these specification sheets.
5. These specification sheets include materials protected under copyright of EVERLIGHT. Reproduction in any form is prohibited without obtaining EVERLIGHT's prior consent.
6. This product is not intended to be used for military, aircraft, automotive, medical, life sustaining or life saving applications or any other application which can result in human injury or death. Please contact authorized Everlight sales agent for special application request.